



13



Screw anchors

- > Selection
- > Double Helix
- > Single Helix
- > Accessories

Selection of Screw Anchors

The selection of the most appropriate Dulmison Screw Anchor for any particular application should be done by comparing the holding capacity of the anchor with the maximum load in the guy wire.

The maximum load in the guy is determined from the line design, the holding strength of the anchor will depend on the soil classification and the size and installing torque for the anchor.

Care must be taken in the anchor selection, and the holding strength must be carefully compared with the maximum guy load, as a poor choice may result in a failure of the anchor.

Soil Classification

The most important factor affecting the holding strength that can be achieved by a screw anchor is the type of soil in which it is installed. The Soil Classification Table (see Page 13-3) has been designed to assist in the identification of the soil. However, while a reasonable assessment of the surface soil type, the holding strength of the anchor will depend on the soil at the depth to which the anchor is driven. Often the soil is different at this level, as different soil strata may be encountered in driving the anchor.

The best way to check the holding strength of the anchor is to do a proof loading (pull out) test on each anchor installation, but this is not always possible nor economical.

Following extensive field trials, it has been established that there is good correlation between the installation torque and the soil conditions. This means that the holding strength of the anchors can be determined from the installation torque.

Tables on page 13-4 show the relationship between the holding strength and the torque applied for several sizes of single and double flight anchors.

Of course the installation torque is only an indication of the soil conditions at the time of installation. Care should therefore be taken when anchors are installed in hard dry ground that may become water logged following rain.

Installation Techniques

The holding strength that can be achieved by an anchor can also be affected by installation technique, and care must be taken by the operator that the soil is not churned by allowing the anchor to act as an auger as it is installed. This is most easily avoided by keeping a downward pressure on the anchor during installation.

Determination of Guy Loads

The maximum design loading in the guy should usually be available as part of the line design information and this design load should be used with the rated strength tables and graph attached to select the most suitable anchor for each job.

Load-Rating Factor

For some loading conditions, however, it may be desirable to use a load rating factor for the holding strength of the anchor. When the continuous (everyday) tension in the guy exceeds 50% of the maximum working tension of the guy, there is a possibility that the anchor may creep. Even though there is no failure of the anchor in the ground, this may lead to relaxation of the guy, and necessitate periodic retensioning. To avoid this, the load rating factor which is found from Page 13-3 should be applied to the holding strength of the anchor.

Selection of Screw Anchors

Rated Holding Strength & Installation Torque

Single Helix	Anchor Size	Soil Classification					
		2	3	4	5	6	7
Holding Strength (kN)	200	115	95	80	60	45	25
Installation Torque (Nm)		7600	5600	3700	2300	1300	400
Holding Strength (kN)	250		105	85	70	50	30
Installation Torque (Nm)			6100	4200	2500	1500	600
Holding Strength (kN)	300		115	95	80	60	40
Installation Torque (Nm)			6800	4400	3100	1750	800

Double Helix	Anchor Size	Soil Classification					
		2	3	4	5	6	7
Holding Strength (kN)	200 + 200		(145)	120	95	70	45
Installation Torque (Nm)			(7900)	5700	3800	2200	6800
Holding Strength (kN)	250 + 250		(165)	135	110	85	60
Installation Torque (Nm)			(8300)	6000	4100	2500	900

Figures inside brackets indicate that consistent installation is difficult, and highly skilled operators are needed.

Screw Anchors

Power Installed Screw Anchors

Double Helix

Installation Torque & Pullout Strength:

Material:

Threads:

Heads:

Rods & Nuts:

Refer to additional holding strength charts.

High strength alloy steel.

All threads are M24 and rated to 160kN mfl.

Heads are covered in protective coating

Hot dipped galvanised.



Eye Nut

Cat. No.	Hole Size
250080	M24

Rod



Cat. No.	Dim. 'L' mm	c/w Eye Nut
250075	2133	Yes
250076	2000	Yes
250064	1067	No
250061	2133	No



Coupling

Cat. No.	Length mm	Outside Dia.
250095	50	Ø 34

Head



Anchor Head Cat. No.	Hub Size	Flight Size	Max. Rated Torque kNm
250005	35	100	9
250053	35	200	9
250037	38	200	11
250055	35	250	9
250054	38	250	11
250058	35	300	9
250056	38	300	11
250059	35	350	9
250057	38	350	11



Screw Anchors

Power Installed Screw Anchors

Single Helix

Installation Torque & Pullout Strength:

Material:

Threads:

Heads:

Rods & Nuts:

Refer to additional holding strength charts.

High strength alloy steel.

All threads are M24 and rated to 160kN mfl.

Heads are covered in protective coating.

Hot dipped galvanised.



Eye Nut

Cat. No.	Hole Size
250080	M24



Rod

Cat. No.	Dim. 'L' mm	c/w Eye Nut
250075	2133	Yes
250076	2000	Yes
250064	1067	No
250061	2133	No

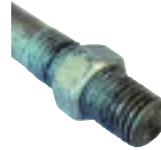

Coupling

Cat. No.	Length mm	Outside Dia.
250095	50	Ø 34



Head

Anchor Head Cat. No.	Hub Size	Flight Size	Max. Rated Torque kNm
250025	35	150	9
250029	35	200	9
250027	38	200	11
250028	35	250	9
250011	38	250	11
250030	35	300	9
250032	38	300	11
250031	35	350	9



Screw Anchors

Hand Installed Screw Anchors

Type HISA

The easy to use multi purpose galvanised anchors you can use again and again.

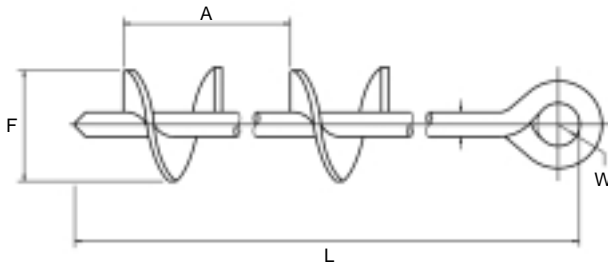
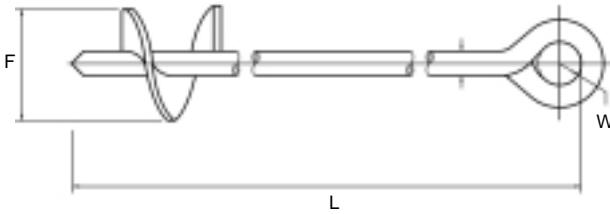

Cat. No.	Length L	Flyte Dia. F	Flyte Sep. A	Radius R	Rod Dia. W
HISA1001	1270	100	-	15	20
HISA1002	1270	100	146	15	20
HISA1003	1800	175	-	15	20

Screw Anchors

Power Installed Screw Anchors

Anchor Accessories

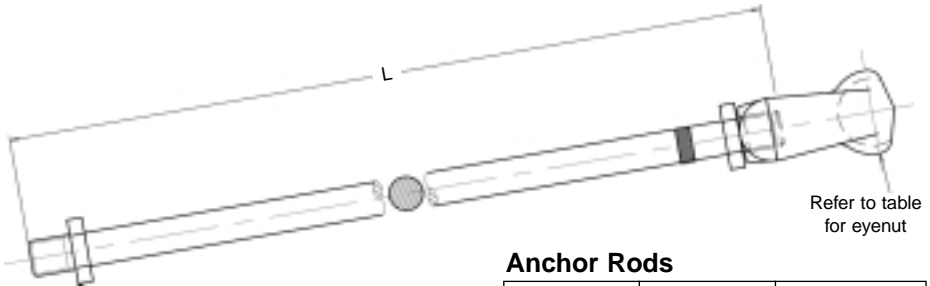

Anchor Rods

Cat. No.	Dim. 'L' mm	c/w Eye Nut
250075	2133	Yes
250076	2000	Yes
250064	1067	No
250061	2133	No

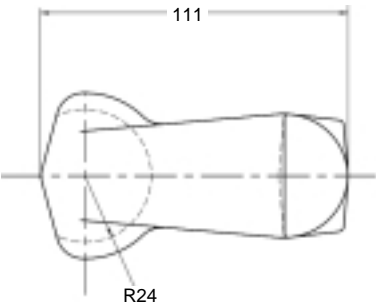

Thimble Eye Nut

Cat. No.	Hole Size
250079	M20
250080	M24
250084	M36

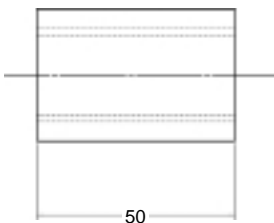
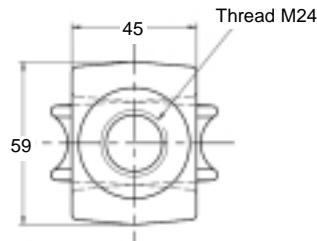
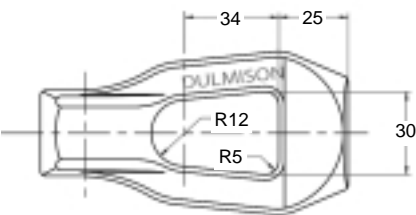

Anchor Couplings

Cat. No.	Length mm	Outside Dia.
250095	50	Ø 34